

# Data Sheet



Article number: 07107303001

Description: Universal joint double 0.107.303.001  
S=228 X= Bore 30 H7 with keyway

## Measures

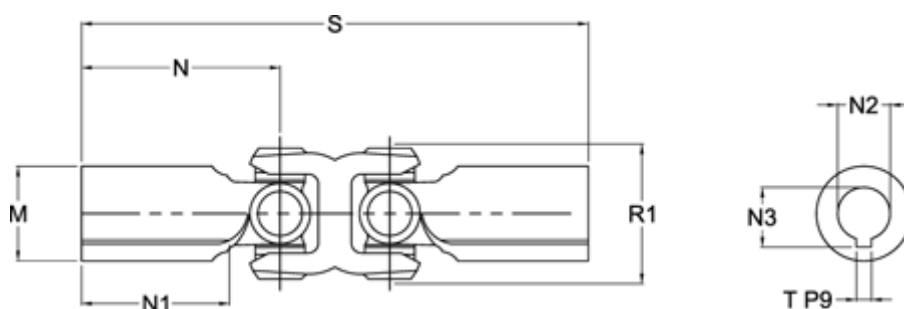

M	= 50	T = 8 P9
Max. Bending Angle degrees	= 30	
N	= 80	
N1	= 46	
N2	= 30 H7	
N3	= 33,3 +0,2	
R1	= 70	
S min	= 228	